

MyFeeder

EN Instruction manual

DE Bedienungsanleitung

FR Mode d'emploi

NL Gebruiksaanwijzing

IT Istruzioni

ES Instrucciones

PT Manual de instruções

SV Bruksanvisning

DA Brugsanvisning

PL Instrukcja użytkownika

CS Návod k použití

RU Руководство по эксплуатации



A



2 × 1.5 V AA

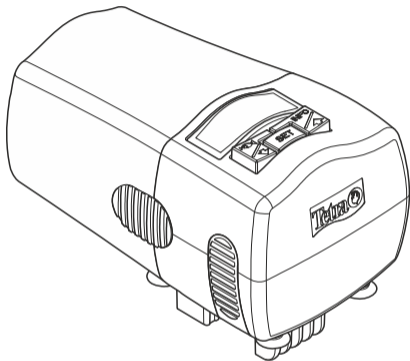
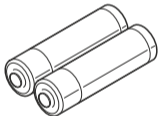

AFR0001



B

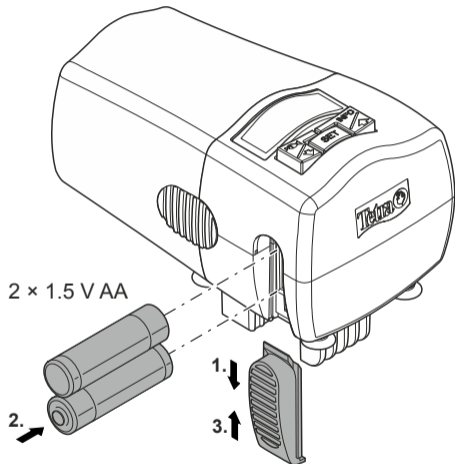

AFR0002



C

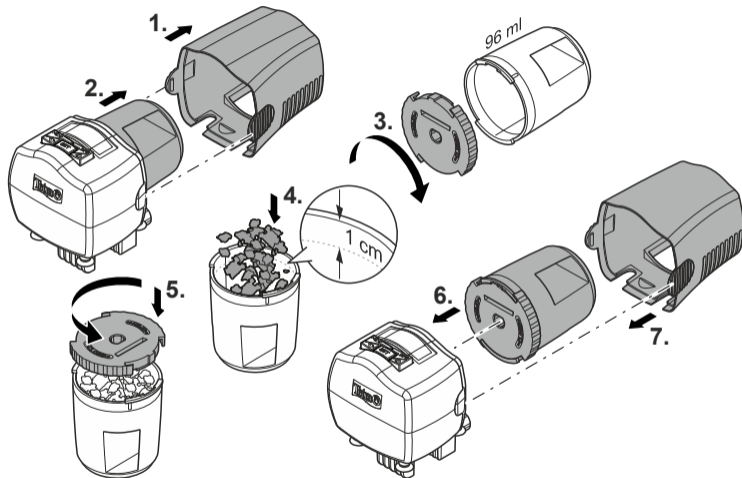

AFR0003



D

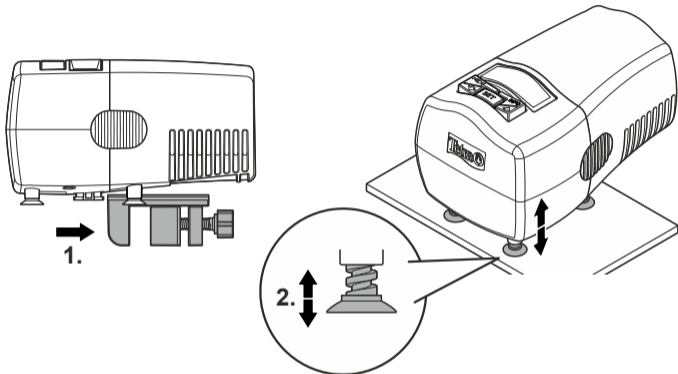

AFR0004



E

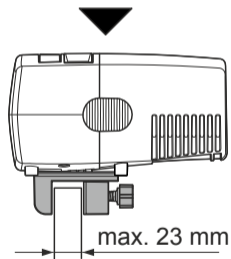
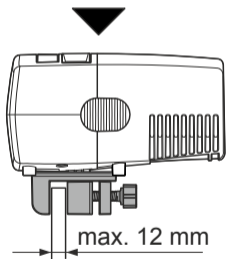
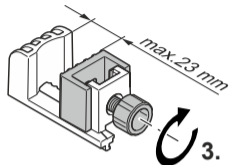
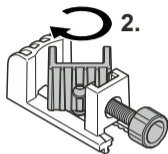
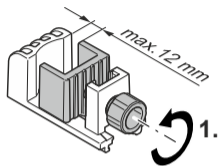



AFR0006

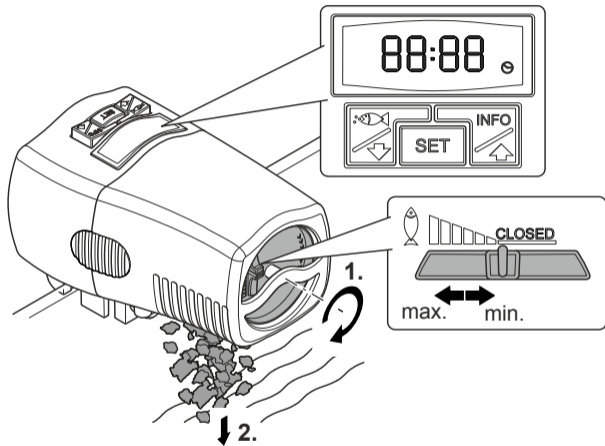

F



AFR0005

F	Display	Function
		Time display (e.g. 1:00 AM)
INFO	<i>BATT -</i> <i>TIME 1 - TURNS -</i> <i>TIME 2 - TURNS-</i> <i>TIME 3 - TURNS</i>	Information (2x) about Battery capacity 1st feed – rations 2nd feed – rations 3rd feed – rations
	<i>FEEDING</i>	1 extra feed
		Set the ration to be dispensed during one turn of the food container.
	<i>REPLACE BATTERIES</i> <i>BATT</i>	Appliance out of operation <ul style="list-style-type: none"> • Replace the batteries with two batteries of the same type. • Always replace both batteries at the same time.

	F	Display	Function	F
1.	SET	*0* CLOCK	Set the time	
	SET	12 HR	Change the display to 24 h CET	⬆
		24 HR	Change the display to 12 h AM/PM	⬇
	SET	1:	Set the hours	⬇ / ⬆
	SET	:00	Set the minutes	⬇ / ⬆
	SET	*0* CLOCK	Save the time	
2.	⬆	*1* FEEDING TIME 1	Set the 1st feeding time	
	SET	ON	Feeding on (ON) / off (OFF)	⬇ / ⬆
	SET	1:	Set the hours	⬇ / ⬆
	SET	:00	Set the minutes	⬇ / ⬆
	SET	TURNS	Set 1 to 3 turns	⬇ / ⬆
	SET	*0* CLOCK	Save the feeding time	
3.	⬆	*2* FEEDING TIME 2	Set the 2nd feeding time	
4.	⬆	*3* FEEDING TIME 3	Set the 3rd feeding time	
5.	⬆	1:00	Exit setting	

RECOMMENDED TYPES OF FOOD

- TetraMin Flake food
- TetraMin Pro Crisps
- TetraMin Granules
- TetraDelica

DISPOSAL

NOTE





Incorrect disposal causes damage to the environment.

- Dispose of the packaging materials in an environmentally friendly way in accordance with the applicable legal regulations.
- Dispose of batteries in an environmentally friendly way.

GUARANTEE

Tetra gives a two year guarantee from the date of purchase. Please keep proof of purchase. The guarantee does not cover improper use, normal wear and tear or modifications to the appliance. In the event of a complaint please contact your retailer, Tetra GmbH or the Tetra Technik Service Center at www.tetra-service.net.

F	Anzeige	Funktion
		Anzeige Uhrzeit (z. B. 1:00 AM)
INFO	<i>BATT -</i> <i>TIME 1 - TURNS -</i> <i>TIME 2 - TURNS-</i> <i>TIME 3 - TURNS</i>	Information (2x) über Batteriekapazität 1. Fütterung – Rationen 2. Fütterung – Rationen 3. Fütterung – Rationen
	<i>FEEDING</i>	1 Extrafütterung
		Ration einstellen, die bei einer Umdrehung des Futterbehälters ausgegeben wird.
	<i>REPLACE BATTERIES</i> <i>BATT</i>	Gerät außer Betrieb <ul style="list-style-type: none"> • Batterien durch zwei neue gleichen Typs ersetzen. • Immer beide Batterien gleichzeitig ersetzen.

	F	Anzeige	Funktion	F
1.	SET	<i>*0* CLOCK</i>	Uhrzeit einstellen	
	SET	<i>12 HR</i>	Anzeige ändern auf 24 h MEZ	⬆
		<i>24 HR</i>	Anzeige ändern auf 12 h AM/PM	⬇
	SET	<i>1:</i>	Stunden einstellen	⬇ / ⬆
	SET	<i>:00</i>	Minuten einstellen	⬇ / ⬆
	SET	<i>*0* CLOCK</i>	Uhrzeit speichern	
2.	⬆	<i>*1* FEEDING TIME 1</i>	1. Fütterungszeit einstellen	
	SET	<i>ON</i>	Fütterung ein (<i>ON</i>) / aus (<i>OFF</i>)	⬇ / ⬆
	SET	<i>1:</i>	Stunden einstellen	⬇ / ⬆
	SET	<i>:00</i>	Minuten einstellen	⬇ / ⬆
	SET	<i>TURNS</i>	1 bis 3 Umdrehungen einstellen	⬇ / ⬆
	SET	<i>*0* CLOCK</i>	Fütterungszeit speichern	
3.	⬆	<i>*2* FEEDING TIME 2</i>	2. Fütterungszeit einstellen	
4.	⬆	<i>*3* FEEDING TIME 3</i>	3. Fütterungszeit einstellen	
5.	⬆	<i>1:00</i>	Einstellung beenden	

EMPFOHLENE FUTTERARTEN

- TetraMin Flockenfutter
- TetraMin Pro Crisps
- TetraMin Granules
- TetraDelica

ENTSORGUNG

HINWEIS





Falsche Entsorgung verursacht Umweltschäden!

- Verpackungsmaterialien umweltgerecht, gemäß der geltenden gesetzlichen Bestimmungen entsorgen.
- Batterien umweltgerecht entsorgen.

GARANTIE

Tetra gewährt Ihnen zwei Jahre Garantie, gerechnet ab Kaufdatum. Kassenbon bitte aufbewahren! Keine Garantie besteht in Fällen unsachgemäßer Behandlung, bei normalem Verschleiß sowie nicht zulässigem Eingriff in die Gerätetechnik. Bei Reklamationen wenden Sie sich bitte an Ihren Händler, an die Tetra GmbH oder an das Tetra Technik Service Center unter www.tetra-service.net.

F	Affichage	Fonction
		Affichage de l'heure (par ex. 1:00 AM)
INFO	<p>BATT -</p> <p>TIME 1 - TURNS -</p> <p>TIME 2 - TURNS-</p> <p>TIME 3 - TURNS</p>	<p>Information (2x) sur la capacité des piles</p> <ol style="list-style-type: none"> 1. Distribution de nourriture – Rations 2. Distribution de nourriture – Rations 3. Distribution de nourriture – Rations
	FEEDING	1 distribution en plus
		Régler la ration devant être distribuée lors d'une rotation du récipient de nourriture.
	<p>REPLACE BATTERIES</p> <p>BATT</p>	<p>Appareil hors service</p> <ul style="list-style-type: none"> • Remplacer les piles par deux piles du même type. • Toujours remplacer les deux piles en même temps.

	F	Affichage	Fonction	F
1.	SET	<i>*0* CLOCK</i>	Réglage de l'heure	
	SET	<i>12 HR</i>	Modification de l'affichage sur 24 h MEZ	⬆
		<i>24 HR</i>	Modification de l'affichage sur 12 h AM/PM	⬇
	SET	<i>1:</i>	Réglage des heures	⬇ / ⬆
	SET	<i>:00</i>	Réglage des minutes	⬇ / ⬆
	SET	<i>*0* CLOCK</i>	Enregistrement de l'heure	
2.	⬆	<i>*1* FEEDING TIME 1</i>	1. Réglage de l'heure de la distribution de nourriture	
	SET	<i>ON</i>	Distribution de nourriture marche (<i>ON</i>) / arrêt (<i>OFF</i>)	⬇ / ⬆
	SET	<i>1:</i>	Réglage des heures	⬇ / ⬆
	SET	<i>:00</i>	Réglage des minutes	⬇ / ⬆
	SET	<i>TURNS</i>	Réglage 1 à 3 rotations	⬇ / ⬆
	SET	<i>*0* CLOCK</i>	Enregistrement de l'heure de la distribution de nourriture	
3.	⬆	<i>*2* FEEDING TIME 2</i>	2. Réglage de l'heure de la distribution de nourriture	
4.	⬆	<i>*3* FEEDING TIME 3</i>	3. Réglage de l'heure de la distribution de nourriture	
5.	⬆	<i>1:00</i>	Fin du réglage	

TYPES DE NOURRITURE RECOMMANDÉS

- TetraMin Flocons
- TetraMin Pro Crisps
- TetraMin Granules
- TetraDelica

MISE AU REBUT

INDICATION





Une mauvaise mise au rebut a des conséquences néfastes pour l'environnement !

- Éliminer les matériaux d'emballage dans le respect de l'environnement conformément aux dispositions légales en vigueur.
- Éliminer les piles dans le respect de l'environnement.

GARANTIE

Tetra vous accorde une garantie de deux ans à compter du jour de l'achat. Veuillez conserver le ticket de caisse ! La garantie ne couvre ni les cas de traitement non-conforme, ni l'usure normale, ni les interventions non-autorisées sur l'appareil. Veuillez vous adresser à votre revendeur, à Tetra GmbH ou au Service Après Vente Tetra sous www.tetra-service.net en cas de réclamation.

F	Weergave	Functie
		Weergave tijd (bijv.. 1:00 AM)
INFO	<i>BATT -</i> <i>TIME 1 - TURNS -</i> <i>TIME 2 - TURNS-</i> <i>TIME 3 - TURNS</i>	Informatie (2x) over Capaciteit batterij 1e voeding – omwentelingen 2e voeding – omwentelingen 3e voeding – omwentelingen
	<i>FEEDING</i>	1 Extra voeding
		Portie instellen, die bij een omwenteling van de voerhouder wordt gedoseerd.
	<i>REPLACE BATTERIES</i> <i>BATT</i>	Apparaat buiten bedrijf <ul style="list-style-type: none"> • Batterijen vervangen door twee nieuwe van hetzelfde type. • Altijd beide batterijen tegelijkertijd vervangen.

	F	Weergave	Functie	F
1.	SET	<i>*0* CLOCK</i>	Tijd instellen	
	SET	<i>12 HR</i>	Weergave veranderen naar 24 h CET	⬆
		<i>24 HR</i>	Weergave veranderen naar 12 h AM/PM	⬇
	SET	<i>1:</i>	Uren instellen	⬇ / ⬆
	SET	<i>:00</i>	Minuten instellen	⬇ / ⬆
	SET	<i>*0* CLOCK</i>	Tijd opslaan	
2.	⬆	<i>*1* FEEDING TIME 1</i>	1e Voertijd instellen	
	SET	<i>ON</i>	Voeren aan(<i>ON</i>) / uit (<i>OFF</i>)	⬇ / ⬆
	SET	<i>1:</i>	Uren instellen	⬇ / ⬆
	SET	<i>:00</i>	Minuten instellen	⬇ / ⬆
	SET	<i>TURNS</i>	1 tot 3 omwentelingen instellen	⬇ / ⬆
	SET	<i>*0* CLOCK</i>	Voertijd opslaan	
3.	⬆	<i>*2* FEEDING TIME 2</i>	2e Voertijd instellen	
4.	⬆	<i>*3* FEEDING TIME 3</i>	3e Voertijd instellen	
5.	⬆	<i>1:00</i>	Instelling beëindigen	

AANBEVOLEN VOER

- TetraMin vlokkenvoer
- TetraMin Pro Crisps
- TetraMin Granules
- TetraDelica

AFVOEREN

OPMERKING





Verkeerd afvoeren heeft schade aan het milieu tot gevolg!

- Voer de verpakkingsmaterialen milieuvriendelijk af, conform de geldende wettelijke bepalingen.
- Batterijen milieuvriendelijk afvoeren.

GARANTIE

Tetra verleent u twee jaar garantie, vanaf de aanschafdatum. Bewaar de kassabon! De garantie is niet van toepassing in geval van verkeerde behandeling, bij normale slijtage en bij ongeautoriseerd ingrijpen in de apparaattechniek. In geval van reclamaties kunt u contact opnemen met uw dealer, Tetra GmbH of het Tetra Technik Service Center onder www.tetra-service.net.

F	Indicazione	Funzione
		Indicazione dell'ora (ad. es. 1:00 AM)
INFO	<p><i>BATT -</i></p> <p><i>TIME 1 - TURNS -</i></p> <p><i>TIME 2 - TURNS-</i></p> <p><i>TIME 3 - TURNS</i></p>	<p>Informazione (2x) sulla capacità della batteria</p> <ol style="list-style-type: none"> 1. somministrazione mangime – razioni 2. somministrazione mangime – razioni 3. somministrazione mangime – razioni
	<i>FEEDING</i>	1 somministrazione mangime straordinaria
		Impostare la razione che viene somministrata ad una rotazione del contenitore del mangime
	<p><i>REPLACE BATTERIES</i></p> <p><i>BATT</i></p>	<p>Apparecchio fuori funzione</p> <ul style="list-style-type: none"> • Sostituire le batterie con due nuove dello stesso tipo. • Sostituire le due batterie sempre insieme.

	F	Indicazione	Funzione	F
1.	SET	<i>*0* CLOCK</i>	Impostazione dell'orologio	
	SET	<i>12 HR</i>	Modifica dell'indicazione su 24 h CET	⬆
		<i>24 HR</i>	Modifica dell'indicazione su 12 h AM/PM	⬇
	SET	<i>1:</i>	Impostazione delle ore	⬇ / ⬆
	SET	<i>:00</i>	Impostazione dei minuti	⬇ / ⬆
	SET	<i>*0* CLOCK</i>	Memorizzazione dell'ora	
2.	⬆	<i>*1* FEEDING TIME 1</i>	1. Impostazione dell'ora di somministrazione del mangime	
	SET	<i>ON</i>	Somministrazione mangime accesa (<i>ON</i>) / spenta (<i>OFF</i>)	⬇ / ⬆
	SET	<i>1:</i>	Impostazione delle ore	⬇ / ⬆
	SET	<i>:00</i>	Impostazione dei minuti	⬇ / ⬆
	SET	<i>TURNS</i>	Regolare da 1 a 3 giri	⬇ / ⬆
	SET	<i>*0* CLOCK</i>	Memorizzazione dell'ora di somministrazione del mangime	
3.	⬆	<i>*2* FEEDING TIME 2</i>	2. Impostazione dell'ora di somministrazione del mangime	
4.	⬆	<i>*3* FEEDING TIME 3</i>	3. Impostazione dell'ora di somministrazione del mangime	
5.	⬆	<i>1:00</i>	Terminare impostazione	

TIPI DI MANGIME RACCOMANDATI

- Mangime in fiocchi TetraMin
- TetraMin Pro Crisps
- TetraMin Granules
- TetraDelica

SMALTIMENTO

AVVISO





Errori nello smaltimento causano danni ambientali!

- Smaltire i materiali di imballaggio in maniera ecosostenibile, secondo le disposizioni di legge vigenti.
- Smaltire le batterie in maniera ecosostenibile.

GARANZIA

Tetra Le offre una garanzia di due anni a partire dalla data di acquisto. Conservare il giustificativo di acquisto! La garanzia decade in caso di uso improprio, di normale usura oppure di intervento non consentito nella parte tecnica dell'apparecchio. In caso di reclami, rivolgersi al proprio rivenditore, alla Tetra GmbH oppure al Tetra Technik Service Center al sito www.tetra-service.net.

F	Indicación	Función
		Indicación de la hora (p. ej. 1:00 AM)
INFO	<p><i>BATT -</i></p> <p><i>TIME 1 - TURNS -</i></p> <p><i>TIME 2 - TURNS-</i></p> <p><i>TIME 3 - TURNS</i></p>	<p>Información (2 veces) sobre la capacidad de la batería</p> <p>La primera alimentación – raciones</p> <p>La segunda alimentación – raciones</p> <p>La tercera alimentación – raciones</p>
	<i>FEEDING</i>	1 alimentación adicional
		Ajustar la ración que debe salir durante un giro del recipiente de forraje.
	<p><i>REPLACE BATTERIES</i></p> <p><i>BATT</i></p>	<p>Equipo fuera de servicio</p> <ul style="list-style-type: none"> • Sustituir las baterías por dos baterías nuevas del mismo tipo. • Sustituir siempre las dos baterías al mismo tiempo.

	F	Indicación	Función	F
1.	SET	<i>*0* CLOCK</i>	Ajustar la hora	
	SET	<i>12 HR</i>	Modificar la indicación a 24 h (hora de Europa Central)	⬆
		<i>24 HR</i>	Modificar la indicación a 12 h am/pm	⬇
	SET	<i>1:</i>	Ajustar las horas	⬇ / ⬆
	SET	<i>:00</i>	Ajustar los minutos	⬇ / ⬆
	SET	<i>*0* CLOCK</i>	Almacenar la hora	
2.	⬆	<i>*1* FEEDING TIME 1</i>	Ajustar el primer tiempo de alimentación	
	SET	<i>ON</i>	Alimentación CON (<i>ON</i>) / DES (<i>OFF</i>)	⬇ / ⬆
	SET	<i>1:</i>	Ajustar las horas	⬇ / ⬆
	SET	<i>:00</i>	Ajustar los minutos	⬇ / ⬆
	SET	<i>TURNS</i>	Ajustar de 1 a 3 giros	⬇ / ⬆
	SET	<i>*0* CLOCK</i>	Almacenar el tiempo de alimentación	
3.	⬆	<i>*2* FEEDING TIME 2</i>	Ajustar el segundo tiempo de alimentación	
4.	⬆	<i>*3* FEEDING TIME 3</i>	Ajustar el tercer tiempo de alimentación	
5.	⬆	<i>1:00</i>	Terminar el ajuste	

TIPOS DE FORRAJE RECOMENDADOS

- Alimento en copos TetraMin
- TetraMin Pro Crisps
- TetraMin Granules
- TetraDelica

DESECHO

INDICACIÓN





Un desecho erróneo daña el medio ambiente.

- Deseche los materiales de embalaje de forma ecológica conforme a las disposiciones legales vigentes.
- Deseche las baterías de forma ecológica.

GARANTÍA

Tetra concede dos años de garantía, calculada a partir de la fecha de compra. Guarde el ticket de compra. No se concede garantía en los casos de un tratamiento inadecuado, un desgaste normal y una intervención no autorizada en la técnica del equipo. En caso de reclamaciones diríjase a su comerciante, a la Tetra GmbH o al centro de servicio técnico de Tetra en www.tetra-service.net.

F	Indicação	Função
		Indicação da hora (p. ex. 1:00 AM)
INFO	BATT - TIME 1 - TURNS - TIME 2 - TURNS - TIME 3 - TURNS	Informação (2x) sobre Capacidade da pilha 1. Alimentação - rações 2. Alimentação - rações 3. Alimentação - rações
	FEEDING	1 alimentação extra
		Programar a ração fornecida por uma volta do recipiente de comida.
	REPLACE BATTERIES BATT	Aparelho fora de operação <ul style="list-style-type: none"> • Substituir as pilhas por duas novas do mesmo tipo. • Substituir sempre ambas as pilhas em conjunto.

	F	Indicação	Função	F
1.	SET	<i>*0* CLOCK</i>	Acertar a hora	
	SET	<i>12 HR</i>	Corrigir a indicação para 24 h HEC	⬆
		<i>24 HR</i>	Corrigir a indicação para 12 h AM/PM	⬇
	SET	<i>1:</i>	Corrigir as horas	⬇ / ⬆
	SET	<i>:00</i>	Corrigir os minutos	⬇ / ⬆
	SET	<i>*0* CLOCK</i>	Armazenar a hora	
2.	⬆	<i>*1* FEEDING TIME 1</i>	1. Corrigir a hora de alimentação	
	SET	<i>ON</i>	Alimentação ON (<i>ON</i>) / OFF (<i>OFF</i>)	⬇ / ⬆
	SET	<i>1:</i>	Corrigir as horas	⬇ / ⬆
	SET	<i>:00</i>	Corrigir os minutos	⬇ / ⬆
	SET	<i>TURNS</i>	Programar 1 até 3 voltas do recipiente	⬇ / ⬆
	SET	<i>*0* CLOCK</i>	Armazenar a hora de alimentação	
3.	⬆	<i>*2* FEEDING TIME 2</i>	2. Corrigir a hora de alimentação	
4.	⬆	<i>*3* FEEDING TIME 3</i>	3. Corrigir a hora de alimentação	
5.	⬆	<i>1:00</i>	Terminar o ajuste	

COMIDAS RECOMENDADAS

- Flocos TetraMin
- TetraMin Pro Crisps
- TetraMin Granules
- TetraDelica

PRODUTOS USADOS

NOTA





Cada eliminação inadequada dá origem a danos ecológicos!

- Eliminar os materiais de embalagem de forma ecológica, conforme as normas legais em vigor.
- Eliminar as pilhas de acordo com as disposições ecológicas.

GARANTIA

Tetra oferece dois anos de garantia pelo produto, a partir da data de aquisição. Guardar o talão de pagamento! A garantia fica excluída em todos os casos de tratamento inadequado, desgaste normal e intervenção não permitida no aparelho. Para apresentar reclamação, pedimos que se dirija ao revendedor, à Tetra GmbH ou ao Tetra Technik Service Center, sob www.tetra-service.net.

F	Visning	Funktion
		Tidvisning (t.ex. 1:00 AM)
INFO	BATT - TIME 1 - TURNS - TIME 2 - TURNS- TIME 3 - TURNS	Information (2x) om batterikapacitet 1. Utfodring – ransoner 2. Utfodring – ransoner 3. Utfodring – ransoner
	FEEDING	1 Extrautfodring
		Ställ in den ranson som foderbehållaren ska ge vid ett varv.
	REPLACE BATTERIES	Enheten ur funktion
	BATT	<ul style="list-style-type: none"> • Byt batterierna mot två nya av samma typ. • Byt alltid båda batterierna samtidigt.

	F	Visning	Funktion	F
1.	SET	<i>*0* CLOCK</i>	Ställa klockan	
	SET	<i>12 HR</i>	Ändra tidvisningen till 24 h MEZ	⬆
		<i>24 HR</i>	Ändra tidvisningen till 12 h AM/PM	⬇
	SET	<i>1:</i>	Ställa in timmarna	⬇ / ⬆
	SET	<i>:00</i>	Ställa in minuterna	⬇ / ⬆
	SET	<i>*0* CLOCK</i>	Spara tidsinställningen	
2.	⬆	<i>*1* FEEDING TIME 1</i>	1. Ställa in utfodringstiden	
	SET	<i>ON</i>	Utfodring på (<i>ON</i>)/av (<i>OFF</i>)	⬇ / ⬆
	SET	<i>1:</i>	Ställa in timmarna	⬇ / ⬆
	SET	<i>:00</i>	Ställa in minuterna	⬇ / ⬆
	SET	<i>TURNS</i>	Ställ in 1 till 3 varv	⬇ / ⬆
	SET	<i>*0* CLOCK</i>	Spara utfodringstiden	
3.	⬆	<i>*2* FEEDING TIME 2</i>	2. Ställa in utfodringstiden	
4.	⬆	<i>*3* FEEDING TIME 3</i>	3. Ställa in utfodringstiden	
5.	⬆	<i>1:00</i>	Avsluta inställningen	

REKOMMENDERADE FODERSLAG

- TetraMin flingfoder
- TetraMin Pro Crisps
- TetraMin Granules
- TetraDelica

OMHÄNDERTAGANDE

OBS!





Felaktigt omhändertagande kan ge miljöskador!

- Omhänderta förpackningsmaterial miljövänligt enligt gällande, lagstiftade bestämmelser.
- Omhänderta batterierna miljövänligt.

GARANTI

Tetra ger 2 års garanti från inköpsdatum. Spara kassakvittot! Garantin gäller inte vid felaktig användning, för normalt slitage samt vid otillåtna, tekniska ingrepp på enheten. Vänd dig till din återförsäljare, Tetra GmbH eller Tetra Technik Service Center på www.tetra-service.net vid reklamationer.

F	Visning	Funktion
		Visning klokkeslæt (f.eks. 1:00 AM)
INFO	<i>BATT -</i> <i>TIME 1 - TURNS -</i> <i>TIME 2 - TURNS-</i> <i>TIME 3 - TURNS</i>	Information (2x) om Batterikapacitet 1. fodring – rationer 2. fodring – rationer 3. fodring – rationer
	<i>FEEDING</i>	1 ekstra fodring
		Indstil den ration, der udleveres, når foderbeholderen drejes én omgang.
	<i>REPLACE BATTERIES</i> <i>BATT</i>	Enheden er ude af drift <ul style="list-style-type: none"> • Udskift batterierne med to nye af samme type. • Udskift altid begge batterier på samme tid.

	F	Visning	Funktion	F
1.	SET	*0* CLOCK	Indstilling af klokkeslæt	
	SET	12 HR	Skift visning til 24 h CET	⬆
		24 HR	Skift visning til 12 h AM/PM	⬇
	SET	1:	Indstilling af timer	⬇ / ⬆
	SET	:00	Indstilling af minutter	⬇ / ⬆
	SET	*0* CLOCK	Lagring af klokkeslæt	
2.	⬆	*1* FEEDING TIME 1	1. Indstilling af fodringstid	
	SET	ON	Fodring til (ON) / fra (OFF)	⬇ / ⬆
	SET	1:	Indstilling af timer	⬇ / ⬆
	SET	:00	Indstilling af minutter	⬇ / ⬆
	SET	TURNS	Indstil 1 til 3 omdrejninger	⬇ / ⬆
	SET	*0* CLOCK	Lagring af fodringstid	
3.	⬆	*2* FEEDING TIME 2	2. Indstilling af fodringstid	
4.	⬆	*3* FEEDING TIME 3	3. Indstilling af fodringstid	
5.	⬆	1:00	Afslut indstilling	

ANBEFALEDE FODERTYPER

- TetraMin flagefoder
- TetraMin Pro Crisps
- TetraMin Granules
- TetraDelica

BORTSKAFFELSE

HENVISNING





Forkert bortskaffelse skader miljøet!

- Bortskaf emballagen miljømæssigt korrekt iht. de gældende lovmæssige bestemmelser.
- Bortskaf batterierne miljømæssigt korrekt.

GARANTI

Tetra yder to års garanti fra købsdato. Gem din kassebon! Der gives ingen garanti i tilfælde af ukorrekt behandling, ved normal slitage samt ved ulovlige indgreb i enhedens elektronik. I tilfælde af reklamationer bedes du henvende dig til din forhandler, til Tetra GmbH eller Tetra Technik Service Center på www.tetra-service.net.

F	Wyświetlacz	Funkcja
		Wyświetlacz czasu (np. 1:00 AM)
INFO	<p><i>BATT -</i></p> <p><i>TIME 1 - TURNS -</i></p> <p><i>TIME 2 - TURNS-</i></p> <p><i>TIME 3 - TURNS</i></p>	<p>Informacja (2×) o</p> <p>Stanie wyczerpania baterii</p> <p>1. karmienie – Porcje</p> <p>2. karmienie – Porcje</p> <p>3. karmienie – Porcje</p>
	<i>FEEDING</i>	1 karmienie dodatkowe
		Wyregulować porcję, która ma być podana przy jednym obrocie pojemnika na karmę.
	<p><i>REPLACE BATTERIES</i></p> <p><i>BATT</i></p>	<p>Urządzenie wyłączone</p> <ul style="list-style-type: none"> • Wymienić baterie na dwie nowe tego samego typu. • Zawsze wymieniać równocześnie obie baterie.

	F	Wyświetlacz	Funkcja	F
1.	SET	<i>*0* CLOCK</i>	Nastawianie czasu zegarowego	
	SET	<i>12 HR</i>	Przełącz wyświetlacz na 24 godz. UCT	⬆
		<i>24 HR</i>	Przełącz wyświetlacz na 12 godz. AM/PM	⬇
	SET	<i>1:</i>	Nastaw godzinę	⬇ / ⬆
	SET	<i>:00</i>	Nastaw minutę	⬇ / ⬆
	SET	<i>*0* CLOCK</i>	Wprowadź czas do pamięci	
2.	⬆	<i>*1* FEEDING TIME 1</i>	1. nastawienie czasu karmienia	
	SET	<i>ON</i>	Karmienie włącz (<i>ON</i>) / wyłącz (<i>OFF</i>)	⬇ / ⬆
	SET	<i>1:</i>	Nastaw godzinę	⬇ / ⬆
	SET	<i>:00</i>	Nastaw minutę	⬇ / ⬆
	SET	<i>TURNS</i>	Nastaw od 1 do 3 obrotów	⬇ / ⬆
	SET	<i>*0* CLOCK</i>	Wprowadź czas karmienia do pamięci	
3.	⬆	<i>*2* FEEDING TIME 2</i>	2. nastawienie czasu karmienia	
4.	⬆	<i>*3* FEEDING TIME 3</i>	3. nastawienie czasu karmienia	
5.	⬆	<i>1:00</i>	Zakończ ustawienia	

ZALECANE RODZAJE KARMY

- TetraMin płatki
- TetraMin Pro Crisps
- TetraMin Granules
- TetraDelica

UTYLIZACJA

WSKAZÓWKA





Niewłaściwa utylizacja wyrządza szkody w środowisku naturalnym!

- Materiały opakowania należy utylizować zgodnie z obowiązującymi przepisami dotyczącymi ochrony środowiska.
- Utylizacja baterii musi być przeprowadzana zgodnie z przepisami dotyczącymi ochrony środowiska.

GWARANCJA

Tetra udziela dwuletniej gwarancji, licząc od daty zakupu. Prosimy o zachowanie rachunku! Roszczenia z tytułu udzielonej gwarancji wygasają w przypadku nieprawidłowej obsługi, objawów zwykłego zużycia i niedozwolonej ingerencji w urządzeniu. W przypadku reklamacji prosimy zwrócić się do punktu nabycia, Tetra GmbH albo Tetra Technik Service Center pod www.tetra-service.net.

F	Displej	Funkce
		Zobrazení času (např. 1:00 AM)
INFO	<i>BATT -</i> <i>TIME 1 - TURNS -</i> <i>TIME 2 - TURNS-</i> <i>TIME 3 - TURNS</i>	Informace (2x) o Kapacita baterií 1. krmení - dávkování 2. krmení - dávkování 3. krmení - dávkování
	<i>FEEDING</i>	1 extra krmení
		Nastavení dávky, která bude vydána při jedné otáčce zásobníku na krmivo.
	<i>REPLACE BATTERIES</i> <i>BATT</i>	Přístroj mimo provoz <ul style="list-style-type: none"> • Vyměnit baterie za dvě nové stejného typu. • Vždy měnit obě baterie současně.

	F	Displej	Funkce	F
1.	SET	*0* CLOCK	Nastavení času	
	SET	12 HR	Změnit zobrazení na 24 hod SEČ	⬆
		24 HR	Změnit zobrazení na 12 hod AM/PM	⬇
	SET	1:	Nastavit hodiny	⬇ / ⬆
	SET	:00	Nastavit minuty	⬇ / ⬆
	SET	*0* CLOCK	Uložit čas	
2.	⬆	*1* FEEDING TIME 1	1. Nastavit dobu krmení	
	SET	ON	Krmení zap. (ON) / vyp. (OFF)	⬇ / ⬆
	SET	1:	Nastavit hodiny	⬇ / ⬆
	SET	:00	Nastavit minuty	⬇ / ⬆
	SET	TURNS	Nastavit 1 až 3 otáčky	⬇ / ⬆
	SET	*0* CLOCK	Uložit dobu krmení	
3.	⬆	*2* FEEDING TIME 2	2. Nastavit dobu krmení	
4.	⬆	*3* FEEDING TIME 3	3. Nastavit dobu krmení	
5.	⬆	1:00	Ukončit nastavení	

DOPORUČENÉ DRUHY KRMIVA

- TetraMin vločkové krmivo
- TetraMin Pro Crisps - lupínky
- TetraMin Granules - granule
- TetraDelica

LIKVIDACE

UPOZORNĚNÍ





Špatná likvidace přístroje způsobí škody na životním prostředí!

- Zajistěte likvidaci všech obalových materiálů způsobem šetrným k životnímu prostředí a v souladu s platnými právními předpisy.
- Baterie likvidujte způsobem šetrným k životnímu prostředí.

ZÁRUKA

Tetra poskytuje záruční dobu dva roky, jež se počítá od data zakoupení. Účet si laskavě uschovejte! Záruka nevzniká v případě nevhodného zacházení, při normálním opotřebení jakož i nepřipustném zásahu do technického vybavení. Při reklamacích se obraťte na svého prodejce, na společnost Tetra GmbH nebo na servisní centrum Tetra Technik na www.tetra-service.net.

F	Индикатор	Функция
		Индикация времени (например 1:00 AM)
INFO	<i>BATT -</i> <i>TIME 1 - TURNS -</i> <i>TIME 2 - TURNS-</i> <i>TIME 3 - TURNS</i>	Информация (2×) о Емкость батареи 1. Кормление - рацион 2. Кормление - рацион 3. Кормление - рацион
	<i>FEEDING</i>	1 Дополнительное кормление
		Настройка рациона, который выдается при повороте емкости для корма.
	<i>REPLACE BATTERIES</i> <i>BATT</i>	Устройство не работает <ul style="list-style-type: none"> • Замените батареи двумя новыми того же типа. • Всегда меняйте одновременно обе батареи.

	F	Индикатор	Функция	F
1.	SET	<i>*0* CLOCK</i>	Установить время	
	SET	<i>12 HR</i>	Поменять индикацию на 24 ч CET	⬆
		<i>24 HR</i>	Поменять индикацию на 12 ч AM/PM	⬇
	SET	<i>1:</i>	Настроить часы	⬇ / ⬆
	SET	<i>:00</i>	Настроить минуты	⬇ / ⬆
	SET	<i>*0* CLOCK</i>	Сохранить время	
2.	⬆	<i>*1* FEEDING TIME 1</i>	1. Установить время	
	SET	<i>ON</i>	Кормление вкл (<i>ON</i>) / выкл (<i>OFF</i>)	⬇ / ⬆
	SET	<i>1:</i>	Настроить часы	⬇ / ⬆
	SET	<i>:00</i>	Настроить минуты	⬇ / ⬆
	SET	<i>TURNS</i>	Установить от 1 до 3 поворотов	⬇ / ⬆
	SET	<i>*0* CLOCK</i>	Сохранить время кормления	
3.	⬆	<i>*2* FEEDING TIME 2</i>	2. Установить время кормления	
4.	⬆	<i>*3* FEEDING TIME 3</i>	3. Установить время кормления	
5.	⬆	<i>1:00</i>	Закончить настройку	

РЕКОМЕНДУЕМЫЕ ВИДЫ КОРМА

- TetraMin
- TetraMin Pro Crisps
- TetraMin Granules
- TetraDelica

УТИЛИЗАЦИЯ

УКАЗАНИЕ







Неправильная утилизация приводит к нанесению ущерба окружающей среде!

- Утилизируйте упаковочные материалы в соответствии с требованиями охраны окружающей среды и действующими законодательными актами.
- Утилизируйте батареи в соответствии с требованиями охраны окружающей среды.

ГАРАНТИЯ

Tetra предоставляет Вам два года гарантии, считая с даты покупки. Пожалуйста, сохраните кассовый чек! Гарантия отменяется в случаях ненадлежащего обслуживания, при нормальном износе, а также при недопустимом вмешательстве в аппаратное обеспечение. В случае рекламаций обращайтесь к вашему продавцу, к Tetra GmbH или к Tetra Technik Service Center по адресу www.tetra-service.net.

TetraMin Flakes

<i>FEEDING TIME</i>	<i>TURNS</i>	  CLOSED		
2	1	6	22 d	0.269 g
3	1	6	14 d	0.269 g
2	2	5	37 d	0.0791 g
3	2	5	24 d	0.0791 g
1	2	6	22 d	0.269 g
2	2	6	11 d	0.269 g
3	2	6	7 d	0.269 g

Distributed in UK by Spectrum Brands (UK) Ltd,
Fir Street, Failsworth, Manchester, M35 0HS,
Reg.-No. GB: 418 130 Phone: +44 (161) 9473000



Tetra GmbH
Herrenteich 78
D-49324 Melle
Germany

For more information: www.tetra.net



TH53601/09-2022